

Scandia Prince



Info

Dining chair in laminated laquered wood in American walnut or American oak. Satin chrome or black bolt base. High back.

Accessories

Seat cushion and plastic gliders

Design

Hans Brattrud, 1959



Dimensions (mm)

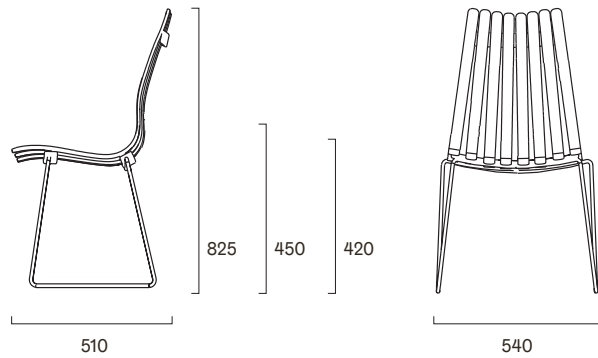

Wood Colours

Walnut



Oak



White Pigmented
Oak



White
NCS S 0300-N



Black
NCS S 9000-1

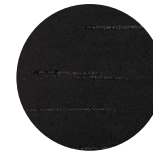

Red
NCS S 4550-Y90R

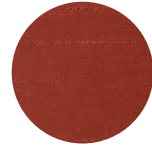

Blue
NCS S 8010-R90B

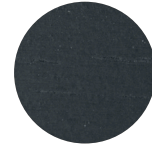

Green
NCS S 8010-G10Y

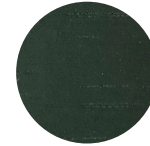

Light Grey
NCS S 2002-B

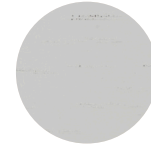

Fully Coloured



Light Edges

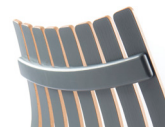

Base Colours

Satin Chrome

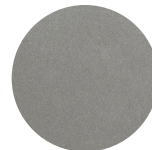

Black Coated
RAL 9005

